

# Designing and Building with Aircrete

How to build successfully

[www.hhcelcon.co.uk](http://www.hhcelcon.co.uk)



GELCON  
PRODUCED IN THE UK  
AIRCRETE EST. 1949  
INSIDE





# Living up to a new promise

H+H is evolving to meet the changing needs of a developing industry. We understand that it is no longer enough to supply high quality products and have developed a distinctive partnership approach, adding value at every stage of the supply chain.

Our customers recognise the benefit of working this way and now is the time to change our branding to reflect our unique brand promise: a minor change in looks reflecting a significant step forward in communicating our difference.

From initial planning through to design, distribution and construction, H+H is committed to adding value at every stage of the building process, recognising that from genuine partnership comes responsive efficient and reliable customer service.

We manufacture the highest quality, technically innovative aircrete components, but more than that, we specialise in the design and construction of high-performance, durable, cost effective structural walls.

With their thermal, acoustic and load bearing capabilities, H+H products offer simple solutions to the latest Building Regulations. In addition to being lightweight they also have the benefits of high resistance to fire, sulfate attack, frost and water penetration.

Since setting up our first research and development laboratory in 1969, H+H has been at the forefront of aircrete research and manufacturing.

A totally focused strategy, combined with specialised resources, has enabled us to undertake pioneering work with solutions including Celcon Blocks, Celcon Plus Blocks, Jumbo Bloks, the H+H Thin-Joint System the Rå Build Method and the H+H MMC build solution with Celcon Elements.



## Contents

02	Living up to a new promise	15	Internal walls	24	Fire resistance
03	Delivering value	16	Movement control	25	CDM regulations
04	Introduction	19	Regulations (acoustics)	26	Good site practice
05	Structural design	20	Acoustic compliance	28	External applied finishes
12	Foundation blocks	22	Robust Details for acoustic performance	32	Internal applied finishes
13	External walls			35	Wall fixings

# Delivering value at every stage

From planners and architects to distributors and builders, we can help all stakeholders in the wall building process. We add value at each stage through sound process expertise combined with a complete, high-quality range.

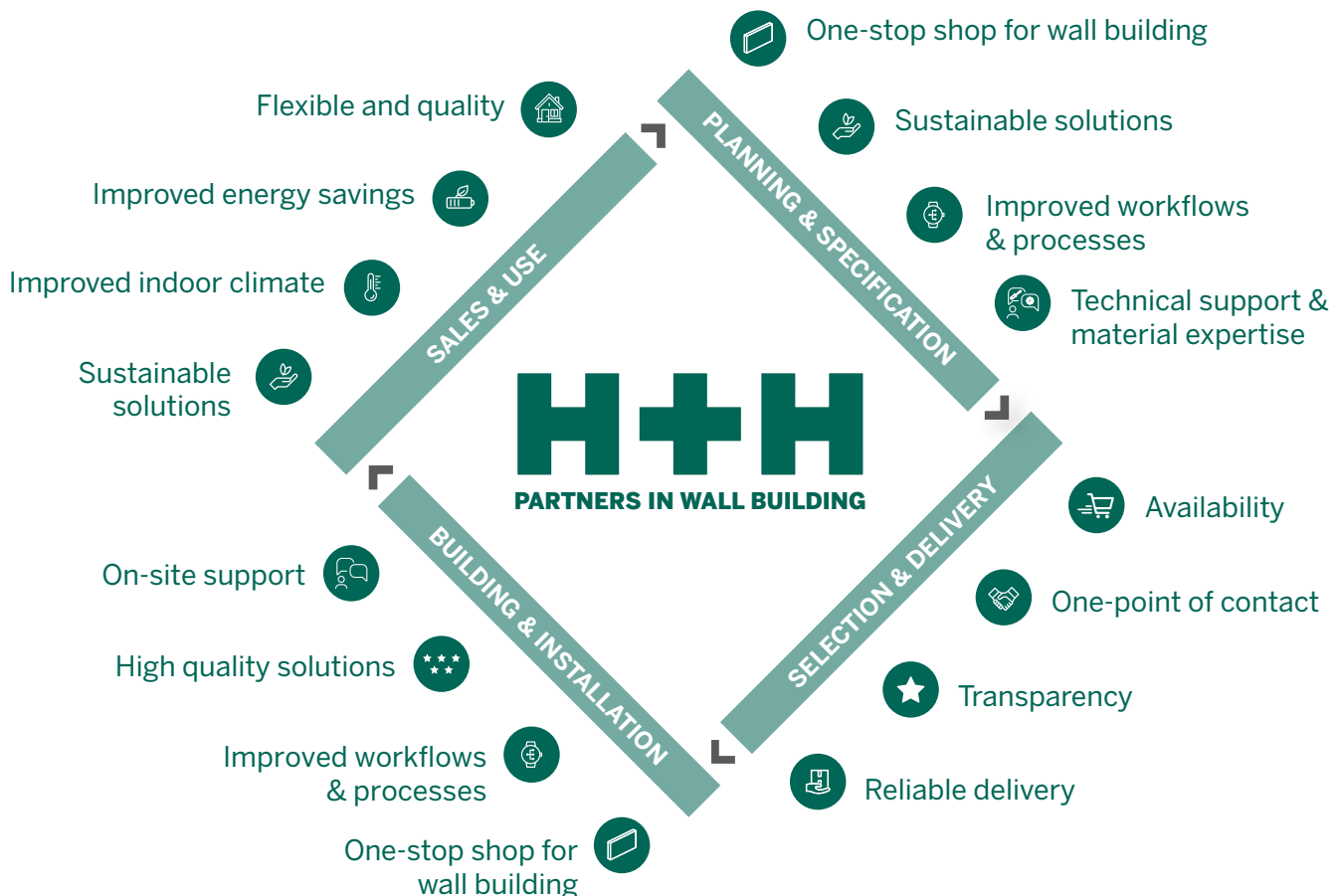

# Introduction

In this guide we have brought together the two areas for using aircrete, the Design process and Building. The first section looks at the Design elements needed to create successful masonry structures and the second how to Build successfully.

## Designing with Aircrete

This has been written to help architects and specifiers achieve the most efficient designs using H+H UK products, whether for low-rise housing or multi storey buildings.

There is detail on Structural Design when building Low Rise Housing (up to three storeys), designing with higher strength blockwork and Eurocode 6. Also included is information on H+H product, from below DPC to roof level, together with their characteristics and uses.

The guide also includes notes on using aircrete in cavity, solid, internal and separating walls. Accommodation of movement, the positioning of joist hangers, restraining straps, wall ties and lintels, along with using aircrete with dissimilar materials are also highlighted in this document.

## Building with Aircrete

This part of the guide has been written to emphasise the practical use and application of H+H UK products.

This includes detailed guidance on: stacking and storage, recommended mortar types and strength, laying blocks, cutting, chasing and fixing to blocks, applying internal and external finishes

### H+H Aircrete

All H+H aircrete is strong and lightweight and easy to work with. Most thicknesses are well below 20 kg, the CONIAC regulation limit for single-handed, repetitive lifting. They are available for use in four grades.

All H+H aircrete products can be finished with render, tile hanging or decorative cladding. They are available in Solar Grade, Standard Grade, High Strength Grade and Super Strength Grade, complying with European product standard BS EN771-4 for aircrete masonry units. Standard Grade, High Strength Grade and Super Strength Grade blocks are principally for wall constructions both above and below DPC. Solar Grade offers enhanced thermal performance and is principally used for the inner leaves of external cavity walls and for solid walls.

Most blocks are available in a wide range of thicknesses from 100mm to 355mm and have the following face dimensions:

**Celcon Blocks all grades**  
440 x 215mm

**Celcon Plus Blocks all grades**  
630 x 215mm

**Jumbo Bloks all grades**  
630 x 250mm

**Foundation Blocks all grades (except Solar Grade)**  
325 x 215mm and 440 x 215mm

### Note

A range of detailed drawings and BIM objects are available on our website [www.hhcelcon.co.uk](http://www.hhcelcon.co.uk)

The latest Material Safety Data information can also be found on our website.

**For more information please contact our Technical Department on 01732 880580 or our Sales Team on 01732 886444.**



## Designing with Aircrete

# Structural design

### Design of Low Rise Housing

The following documents set out simple design guidance for low rise housing:

- **The Building Regulations Approved Document 'A' for England and Wales.**
- **Small Buildings Structural Guidance document for the Building (Scotland) Regulations.**
- **BS 8103-2 (Structural design of low rise buildings – Part 2 Code of Practice for Masonry Walls for housing).**

These give block strength requirements for certain types of buildings in accordance with European Standards. H+H products are manufactured to meet the requirements of the above documents.

The general structural requirements of these documents are summarised (drawing 01), where for two storey housing the minimum strength for blocks is 2.9N/mm<sup>2</sup> and for three storey housing, the lowest storey is 7.3N/mm<sup>2</sup>, whilst 2.9N/mm<sup>2</sup> is retained at the two upper levels. Thus, all grades of H+H aircrete can be used where 2.9N/mm<sup>2</sup> blocks are shown (drawing 01) and blocks from the higher strength grades range can be used at the lower storey of a three storey building. It should be remembered that structural calculations can still be carried out, which may lead to a more economical solution.



Declared Compressive Strength Values of H+H Aircrete				
	Solar Grade	Standard Grade	High Strength Grade	Super Strength Grade
BS EN 771-4	2.9N/mm <sup>2</sup>	3.6N/mm <sup>2</sup>	7.3N/mm <sup>2</sup>	8.7N/mm <sup>2</sup>

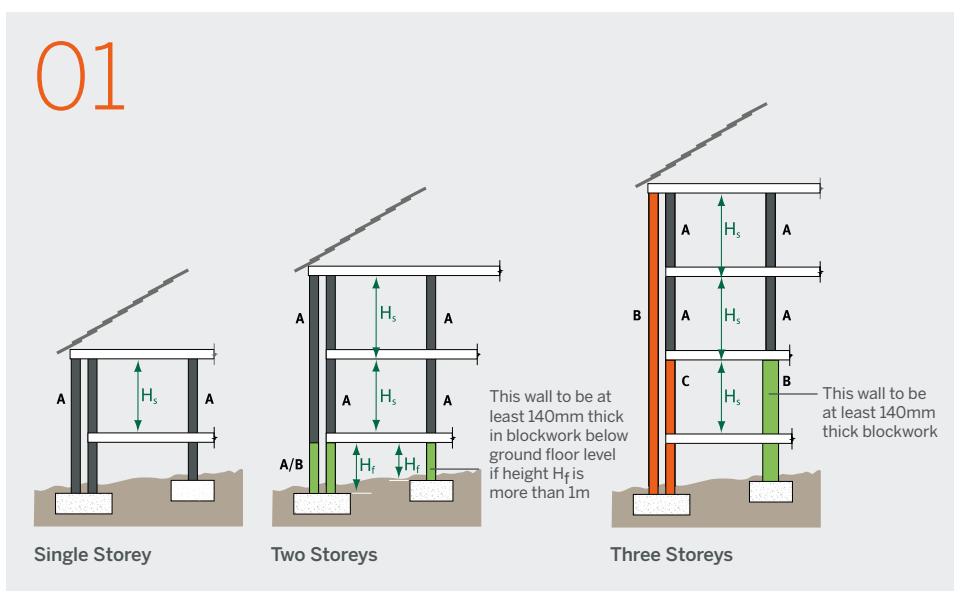

### Notes

1. If  $H_s$  is not more than 2.7m, the compressive strength of blocks used in the wall should be as indicated by the key.
2. If  $H_s$  is more than 2.7m, the compressive strength of blocks used in the wall should be at least Condition B, or as indicated by the key whichever is greater.
3. If the external wall is solid construction, the blocks should have a compressive strength of at least that shown for the internal leaf of a cavity wall in the same position.
4. Timber roof construction, 12m max span.
5. Timber or concrete floor, 6m max span.
6. Wall lengths 12m max.

This diagram is taken from Figure 12 and Table 5 of BS 8103-2

### Key: Min Strength

- A** 2.9N/mm<sup>2</sup> where  $H_s$  is 2.7m max
- A/B**  $H_s$  less than or equal to 1m – 2.9N/mm<sup>2</sup>  
 $H_s$  greater than 1m – 7.3N/mm<sup>2</sup>
- B & C** 7.3N/mm<sup>2</sup>

# Structural design

## Continued...

Where the layout of the dwelling is outside this guidance or it is greater than three storeys, a structural design calculation is necessary.

The requirements for disproportionate collapse effectively limit masonry constructions to four storeys. Aircrete can of course be used for infill blockwork to multi storey framed buildings.

### Designing with Higher Strength Blockwork

When designing in accordance with BS-5628-1 or Eurocode 6, account will be taken of a number of factors. To calculate how much load any given wall can take, the following are considered:

1. **The basic strength of the masonry ( $f_k$ ), which will depend on the block size, block strength and mortar strength.**
2. **The material safety factor and the quality control of the blocks used as well as the site workmanship.**
3. **The wall configuration (which is independent of the block type).**

For designs to BS5628, the characteristic compressive strength of masonry,  $f_k$ , should be obtained from Tables 2a - 2h (based on mortar strength and size of masonry unit). Given below in Table 1 are values interpolated from BS5628 Table 2 which are relevant to walls constructed with H+H aircrete blocks.

### Design to EC6

Given the vast array of different materials, sizes and shapes of units available across Europe, it was decided when developing EC6 that a single formula approach would be more viable than a tabulated one. However, in order for this to work, the compressive strength of each unit would have to be standardised

Table 1

Characteristic compressive strength, $f_k$ , of masonry (to BS5628:Pt1) for H+H Aircrete blocks										
Block			Designation (iii)/M4 Mortar Block type (declared compressive strength) N/mm <sup>2</sup>				Celfix thin layer mortar Block type (declared compressive strength) N/mm <sup>2</sup>			
Height	Thickness	H/t	Solar (2.9)	Standard (3.6)	High Strength (7.3)	Super Strength (8.7)	Solar (2.9)	Standard (3.6)	High Strength (7.3)	Super Strength (8.7)
140mm	215mm	0.65	1.5	1.8	3.3	3.7	1.5	1.8	3.5	4.0
	300mm	0.47	1.3	1.5	2.9	3.3	1.3	1.5	3.1	3.5
	350mm	0.40	1.2	1.4	2.7	3.1	1.2	1.4	2.9	3.3
215mm	75mm	2.87	2.8	3.5	6.4	7.2	2.8	3.5	6.8	7.7
	100mm	2.15	2.8	3.5	6.4	7.2	2.8	3.5	6.8	7.7
	140mm	1.54	2.3	2.9	5.3	6.0	2.3	2.9	5.7	6.4
	150mm	1.43	2.2	2.8	5.1	5.8	2.2	2.8	5.4	6.1
	200mm	1.08	1.9	2.3	4.3	4.8	1.9	2.3	4.6	5.2
	215mm	1.00	1.8	2.2	4.1	4.6	1.8	2.2	4.4	4.9
	275mm	0.78	1.6	1.9	3.6	4.1	1.6	1.9	3.8	4.3
	300mm	0.72	1.5	1.8	3.5	3.9	1.5	1.8	3.7	4.2
	325mm	0.66	1.5	1.8	3.3	3.8	1.5	1.8	3.5	4.0
	350mm	0.61	1.4	1.7	3.2	3.6	1.4	1.7	3.4	3.9
250mm	100mm	2.50	-	-	-	-	2.8	3.5	6.8	7.7
	140mm	1.79	-	-	-	-	2.6	3.2	6.3	7.1

or 'normalised'. The normalised mean compressive strength,  $f_b$ , used in EC6 is the compressive strength of an air dry 100mm cube of a masonry unit.

### Normalised compressive strength, $f_b$ , of blocks

The normalised compressive strength of a masonry unit is a calculated value used to determine the wall strength and should not be confused with the declared mean compressive strength of a block which is a measured property.

The values currently declared by manufacturers in the UK are mean air dry strengths for the complete brick or block unit (e.g. for H+H aircrete 2.9, 3.6, 7.3 and 8.7N/mm<sup>2</sup>). Compressive strengths are

given in N/mm<sup>2</sup>, i.e. it is the compressive stress of material. The thickness of the blocks are therefore irrelevant (although a 140mm thick block will obviously carry more load than a 100mm block by virtue of its greater area). In order to obtain the normalised strength, the declared mean strengths will need to be multiplied by a shape factor relative to the size of the unit.

The value of the shape factor is given in Table A.1 of EN 772-1 (relevant values applicable to H+H blocks have been interpolated and are given in Table 2).

Although it appears that compressive strength varies with size, it is worth noting that it is not the strength of the

masonry unit which alters with its size but merely the effect it has on the overall strength of the wall into which is built.

The characteristic compressive strength of masonry designed to BS EN 1996-1 is given by;

$$f_k = K \cdot f_b^\alpha \cdot f_m^\beta$$

Where  $f_b$  is the normalised compressive strength of the unit,  $f_m$  is the mortar strength (not greater than  $f_b$ ) and K,  $\alpha$  and  $\beta$  are constants taken from the UK National Annex.

**Table 2**

Normalised Compressive Strengths, $f_b$ , for H+H Aircrete Blocks in N/mm <sup>2</sup>						
Block			Block Type (Declared compressive strength, N/mm <sup>2</sup> )			
Height	Thickness	Shape Factor	Solar (2.9)	Standard (3.6)	High Strength (7.3)	Super Strength (8.7)
140mm	215mm	0.95	2.7	3.4	6.9	8.2
	250mm+	0.91	2.6	3.3	6.6	7.9
215mm	75mm	1.43	4.1	5.1	10.4	12.4
	100mm	1.38	4.0	5.0	10.1	12.0
	140mm	1.30	3.8	4.7	9.5	11.3
	150mm	1.28	3.7	4.6	9.3	11.1
	200mm	1.18	3.4	4.2	8.6	10.3
	215mm	1.16	3.4	4.2	8.5	10.1
	250mm+	1.12	3.2	3.2	4.0	8.1
250mm	100mm	1.45	4.2	5.2	10.6	12.6
	140mm	1.37	4.0	4.9	10.0	11.9



# Structural design

## Continued...

Table 3 gives calculated  $f_k$  values for walls built using H+H aircrete of different sizes in both traditional mortar and Celfix thin layer mortar.

### Characteristic flexural strength of masonry

The design for lateral load in EC 6 is based on UK design practice and is similar to BS5628:Pt 1 with the values for characteristic flexural strength in the National Annex being identical to the values BS5628. Interpolated figures relevant to H+H aircrete are given in Table 4.

### Effect of partial safety factors

Both compressive and flexural design strengths incorporate a material partial safety factor in their determination. H+H High Strength (7.3N/mm<sup>2</sup>) and Super Strength (8.7N/mm<sup>2</sup>) blocks are manufactured to special category of manufacturing control (i.e. Category I) which permits a reduced material partial safety factor to be used in design calculations. Furthermore, our Celfix thin layer mortar is factory produced to BS EN 998-2 which enables the utilisation of special category of construction control (Class 1 execution control in EC6).



Table 3

Characteristic Compressive Strength, $f_k$ , of Masonry (to EC 6) for H+H Aircrete Blocks in N/mm <sup>2</sup>									
Block		Designation (iii)/M4 Mortar (K = 0.75, $\alpha = 0.7$ , $\beta = 0.3$ , $f_m = 4\text{N/mm}^2$ )				Celfix thin layer mortar (K = 0.9, $\alpha = 0.85$ , $\beta = 0$ , $f_m = 10\text{N/mm}^2$ )			
Height	Thickness	Block Type (Declared compressive strength, N/mm <sup>2</sup> )				Block Type (Declared compressive strength, N/mm <sup>2</sup> )			
		Solar (2.9)	Standard (3.6)	High Strength (7.3)	Super Strength (8.7)	Solar (2.9)	Standard (3.6)	High Strength (7.3)	Super Strength (8.7)
140mm	215mm	2.1	2.6	4.4	5.0	2.1	2.5	4.6	5.4
	250mm+	2.0	2.5	4.3	4.8	2.1	2.5	4.5	5.2
215mm	75mm	2.9	3.6	5.9	6.6	2.9	3.6	6.6	7.7
	100mm	2.9	3.5	5.7	6.5	2.9	3.5	6.4	7.4
	140mm	2.8	3.3	5.5	6.2	2.8	3.3	6.1	7.1
	150mm	2.8	3.3	5.4	6.1	2.7	3.3	6.0	7.0
	200mm	2.6	3.1	5.1	5.8	2.6	3.1	5.6	6.5
	215mm	2.5	3.1	5.1	5.7	2.5	3.0	5.5	6.4
	250mm+	2.4	3.0	4.9	5.6	2.4	2.9	5.3	6.2
250mm	100mm	-	-	-	-	2.9	3.6	6.7	7.8
	140mm	-	-	-	-	2.9	3.5	6.4	7.4



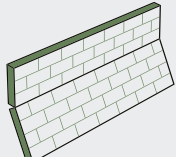
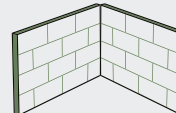

**Table 4**

Characteristic Flexural Strength, $f_{xk1}$ and $f_{xk2}$ , of Masonry to EC 6 for H+H Aircrete Blocks in N/mm <sup>2</sup>								
Block	Values of $f_{xk1}$ Plane of failure parallel to bed joints				Values of $f_{xk2}$ Plane of failure parallel to bed joints			
								
	Block Type (Declared compressive strength, N/mm <sup>2</sup> )				Block Type (Declared compressive strength, N/mm <sup>2</sup> )			
Thickness	Solar (2.9)	Standard (3.6)	High Strength (7.3)	Super Strength (8.7)	Solar (2.9)	Standard (3.6)	High Strength (7.3)	Super Strength (8.7)
75mm		0.25			0.40	0.45	0.60	0.60
100mm		0.25			0.40	0.45	0.60	0.60
140mm		0.22			0.36	0.40	0.53	0.53
150mm		0.22			0.35	0.38	0.52	0.52
200mm		0.18			0.30	0.32	0.43	0.43
215mm		0.17			0.29	0.30	0.41	0.41
250mm+		0.15			0.25	0.25	0.35	0.35

Values applicable to walls built with both traditional M4 mortar or H+H Celfix thin layer mortar

# Structural design

## Continued...

These two factors combined mean that a reduced partial safety factor,  $\gamma_M$ , of 2.5 (BS 5628:Pt1 Table 4) may be used for both compression and flexure when designing to BS 5628 (see Table 5).

This can be equivalent to an additional improvement of at least 20% to wall strength when compared to the safety factors of 3.1 or 3.5 normally assumed.

Standard (3.6N/mm<sup>2</sup>) and Solar (2.9N/mm<sup>2</sup>) blocks are normal category (Category II), therefore a slightly higher safety factor of 2.8 applies to compressive strength although 2.5 is still applicable for flexure.

For designs to EC6, the UK National Annex offers similar, though less pronounced, benefits. Values for  $\gamma_M$  for the ultimate limit state are given in Table NA.1 of the National Annex (see Table 6).

In addition, it offers advantages to designers with regards to safety factors where the masonry is an infill panel to a framed structure. Panels within a framed structure can be classified as being in 'laterally loaded wall panel when the removal of the panel would not affect the overall stability of the building'.

Further guidance on structural design using Eurocode 6, including worked examples, can be found at [www.eurocode6.org](http://www.eurocode6.org).

**Table 5**

Partial Safety Factors for Material Strength $\gamma_M$ from BS5628:Pt 1 Table 4						
	Grade of H+H Aircrete		Category of Manufacturing Control	Category of Construction Control		
				Traditional Mortar		H+H Celfix
				Special	Normal	Thin Layer Mortar*
Compression, $\gamma_M$	Super Strength	(8.7N.mm <sup>2</sup> )	Category I	2.5	3.1	2.5
	High Strength	(7.3N.mm <sup>2</sup> )				
	Standard	(3.6N.mm <sup>2</sup> )	Category II	2.8	3.5	2.8
	Solar	(2.9N.mm <sup>2</sup> )				
Flexure, $\gamma_M$	Super Strength	(8.7N.mm <sup>2</sup> )	Category I	2.5	3.0	2.5
	High Strength	(7.3N.mm <sup>2</sup> )				
	Standard	(3.6N.mm <sup>2</sup> )	Category II			
	Solar	(2.9N. mm <sup>2</sup> )				

\* Use of H+H Celfix thin layer mortar would enable Special category of construction control to be assumed

**Table 6**

Partial Safety Factors for Material Strength $\gamma_M$ from NA to BS EN 1996-1-1, Table NA.1						
	Grade of H+H Aircrete		Category of Manufacturing Control	Class of Execution Control		
				Traditional Mortar		H+H Celfix
				1	2	Thin Layer Mortar*
Compression, $\gamma_M$	Super Strength	(8.7N.mm <sup>2</sup> )	Category I	2.3	2.7	2.3
	High Strength	(7.3N.mm <sup>2</sup> )				
	Standard	(3.6N.mm <sup>2</sup> )	Category II	2.6	3.0	2.6
	Solar	(2.9N. mm <sup>2</sup> )				
Flexure, $\gamma_M$ (when removal of panel would affect overall stability of the building)	Super Strength	(8.7N.mm <sup>2</sup> )	Category I	2.3	2.7	2.3
	High Strength	(7.3N.mm <sup>2</sup> )				
	Standard	(3.6N.mm <sup>2</sup> )	Category II			
	Solar	(2.9N. mm <sup>2</sup> )				
Flexure, $\gamma_M$ (when removal of panel would not affect overall stability of the building)	Super Strength	(8.7N.mm <sup>2</sup> )	Category I	2.0	2.4	2.0
	High Strength	(7.3N.mm <sup>2</sup> )				
	Standard	(3.6N.mm <sup>2</sup> )	Category II			
	Solar	(2.9N. mm <sup>2</sup> )				

\* Use of H+H Celfix thin layer mortar would enable Class 1 execution control to be assumed

### Restraint and Connections

Walls should be adequately restrained at the level of intermediate floors and at the roof. Detailed guidance is contained in Building Regulations Approval Document A, Small Buildings Structural Guidance Document for the Building (Scotland) Regulations, BS8103-1, Eurocode 6 and PD6697:2019.

Where floor joists bear onto the supporting walls and joist hangers have not been specified, then cut aircrete or H+H Coursing Units should be used to infill between the joists. All H+H blocks can easily be cut to size on site.

Where joists run parallel to the wall, the three joists nearest the wall should be connected to it by suitable metal restraint straps and located at maximum 2m centres, in line with the documents above. These straps should have an anchorage turn-down at the wall face of at least 100mm and there should be diagonal strutting between the three joists. In order that the restraining straps

are able to act in compression as well as in tension, there should also be adequate packing fixed between the wall and the first joist (drawing 02).

### Joist Hangers

Where joist hangers are used, they should comply with BS EN 845-1. The type and size of hanger must be selected to suit the span and dimensions of the joist to be supported. Suitable proprietary types are available to suit all aircrete strengths.

When hangers are to be built in, care should be taken to ensure their back plates are tight against the surface of the wall (drawing 03). Also, in accordance with the hanger manufacturer's recommendations, the hanger flanges must be held in position by a sufficient height of masonry above. Restraint type hangers should be provided every 2m OR restraint straps provided at maximum 2m centres. The masonry above the hangers should be allowed to mature adequately before the hangers are loaded.

As an alternative, when using Thin Jointed H+H aircrete, proprietary joist hangers may be retrofitted in to the face of previously built blockwork. This method compliments the speed and quality of the thin joint blockwork method of construction. Further details and guidance on installation may be obtained from our Technical Department. Retrofitted hangers are not suitable for use with traditional mortars.

For roof and/or wall connections at gables and at separating walls, restraint straps of the same specification installed as described previously, should be used. These straps should be positioned at maximum 2m centres at rafter (gable verge line) level and at truss tie (ceiling) level.

For further guidance see Section 1c of Approved Document A to the Building Regulations (England & Wales) and BS 8103-2.

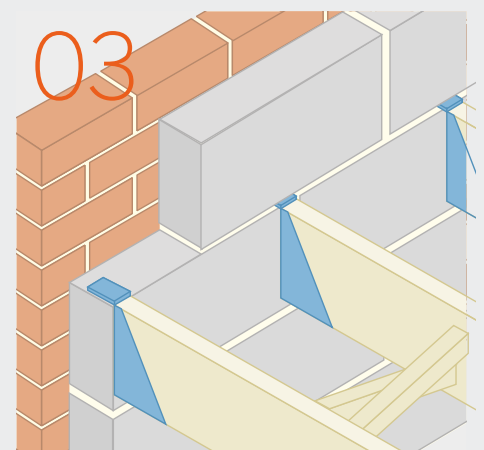
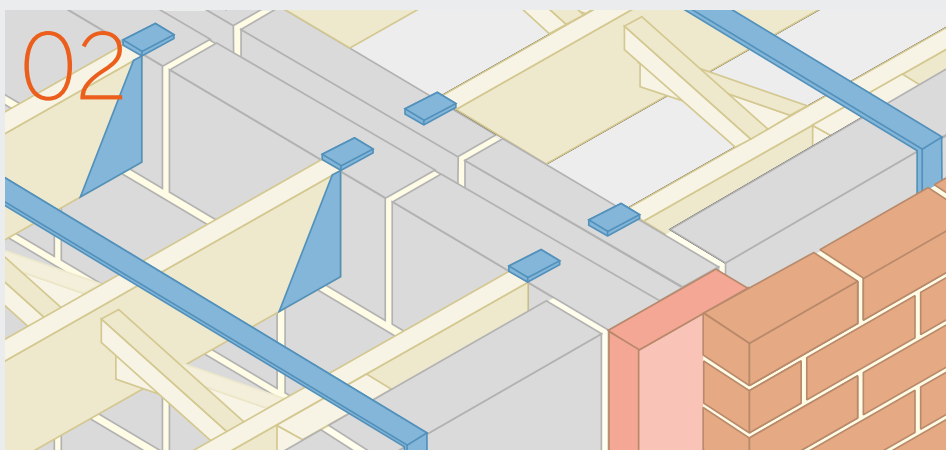

# Foundation Blocks

## Cavity foundation walls

(drawings 04 and 05)

H+H aircrete can be used for both the internal and external leaves of cavity foundations.

## Solid foundation walls

(drawings 06 and 07)

Foundation Blocks of 215mm thickness and upwards can be used for solid foundation walls. The foundation blocks used should be at least the thickness of the wall it supports.

## Omission of mortar from the vertical cross-joints (perpends) in solid foundations

A wall below ground level which is backfilled both sides is not subject to any of the lateral loads which could apply above ground and may be laid with mortared horizontal bed joints and then simply butted together. This is confirmed in the Building Research Establishment (BRE) Information Paper (IP) 7/05; '... for below-ground construction – unless the masonry forms a retaining wall or basement walls – plain-ended units can be used with unfilled vertical joints so long as the units are built with their ends closely butted together to stop the passage of vermin.'

## Frost resistance

H+H Foundation Blocks have exceptionally good frost resistance. BBA appraisal includes assessment of the resistance of the blocks to the freeze/thaw conditions likely to occur below ground level (BBA method of assessment and test, MOAT 12).

Where external finishes, such as render, are terminated at DPC, exposed aircrete should be protected using bituminous paint, suitable for external use, or similar surface coating, applied from 150mm below soil level up to DPC (drawings 06 and 07).

## Soil conditions

The raw materials used in the production of H+H Foundation Blocks give them excellent resistance to sulfate attack and frost damage, making them ideal for use below ground in soil conditions unsuitable for many other types of masonry. Sulfates in clay soils and associated ground water are defined in BRE Special Digest 1, 2005 table 2. BBA certificate 01/3816 confirms that H+H aircrete can be used in classes up to and including DS4. Building control should be able to advise on local soil conditions and whether the soil/ground water conditions require further advice.

## Improved thermal insulation

The use of H+H aircrete in foundation walls helps reduce the heat loss from ground floors (U-value) and more importantly, significantly reduces linear thermal bridging at the floor junction (psi value).

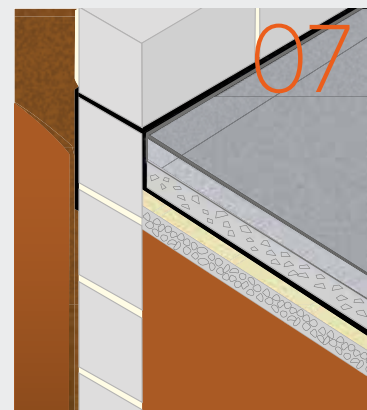
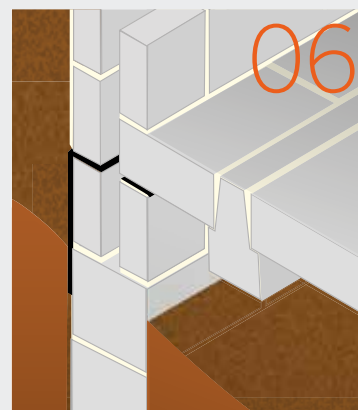
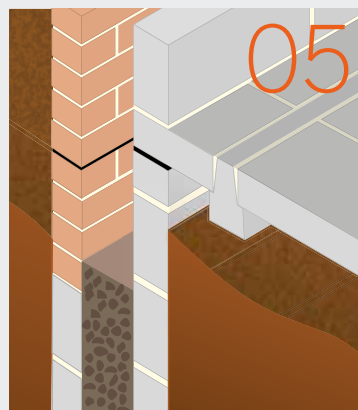
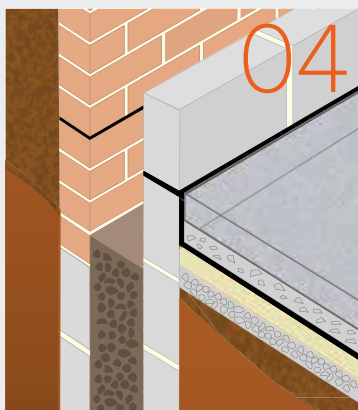

# External walls

## Solid walls

Due to aircrete's closed cell structure it has an excellent resistance to water penetration, therefore enabling it to be used in the construction of solid external walls. This is recognised in:

- Approved Document C.
- PD6697 where for conditions up to and including severe exposure (zone 3), rendered 215mm H+H aircrete is acceptable where similar walls of brick or dense concrete masonry would need to be thicker.
- This is also confirmed in our BBA Certificate 01/3816.

## Cavity walls

In an external cavity wall construction, each leaf predominately meets specific requirements. The external leaf protects the structure from the penetration of moisture, whilst the inner leaf provides the main structural support of the building. H+H aircrete fulfills both of these requirements.

## Loadbearing

For the loadbearing inner leaf aircrete offers a choice of solutions and strengths:

- Two storey housing – Solar Grade 2.9N/mm<sup>2</sup> and Standard Grade 3.6N/mm<sup>2</sup> grade blocks are normally more than adequate to meet structural requirements.
- Multi storey construction walls or piers under high vertical loads – higher strength blocks may be required.

For further information, see drawing 01 on page 5.

## Wall ties

Wall ties should be adequately stiff yet sufficiently flexible to allow some relative movement between the two leaves. The type of tie will depend on the cavity width. Ties should conform to BS EN 845-1. For further advice contact our Technical Services Department.

In external cavity walls, ties should have a minimum embedment of 50mm into each leaf. For walls in which both leaves are 90mm or thicker, the ties should be at a maximum spacing of 900mm horizontally and 450mm vertically, (density of 2.5 ties/m<sup>2</sup>), and the ties

should be evenly distributed over the wall area, normally in a staggered pattern.

Additional ties should be provided in the following situations:

- Within 225mm of the vertical edge of all window and door openings (drawings 08 and 09).
- At vertical unreturned edges, including movement joints.
- At sloping unreturned edges, such as at the roof verge (drawing 10).
- At narrow piers.

See Eurocode 6 and PD6697 for further details.

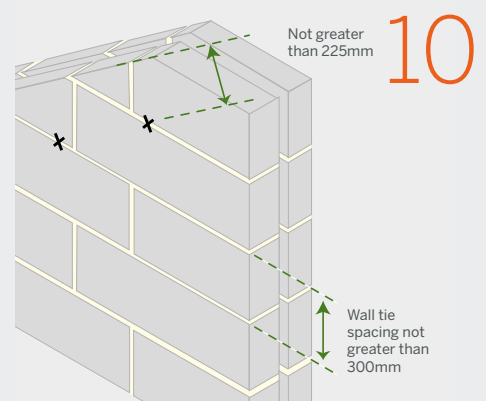
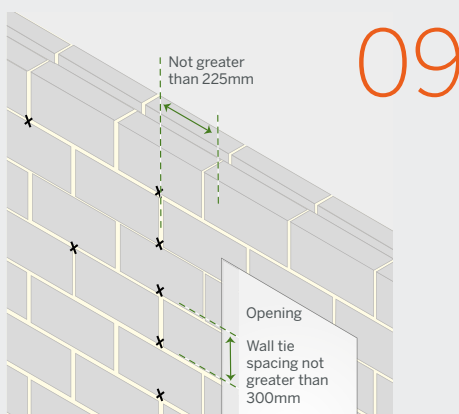
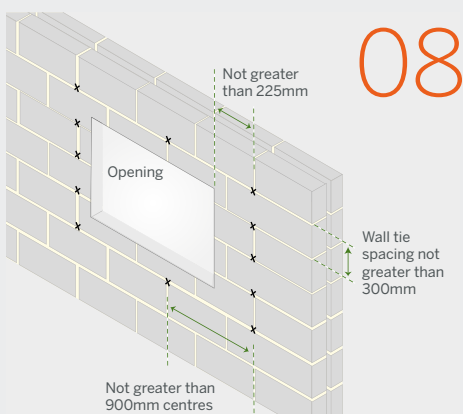

# External walls

Continued...

## Lintels

Blockwork should be set out to ensure that, wherever possible, all lintels bear upon full blocks, not onto a short length of cut block (Eurocode 6). The bearing should normally be at least 150mm in length.

Where stresses under lintel bearings are likely to exceed permissible values or where there are large concentrated loads, concrete spreaders or padstones should be incorporated (drawing 11).

In accordance with general good practice when using thin-joint the provision of a slip plane between one end of the lintel and the bearing is advised (drawing 12).

## Lintels for solid walls

Aircrete can easily be chased-out on site to accommodate proprietary metal lintels (drawing 13). Alternatively, for wider solid walls, cavity type lintels can be used within 100mm blocks laid either side of the up stand.

## Lintels for internal partition walls

Light-duty lintels may be used when opening widths and loadings permit.

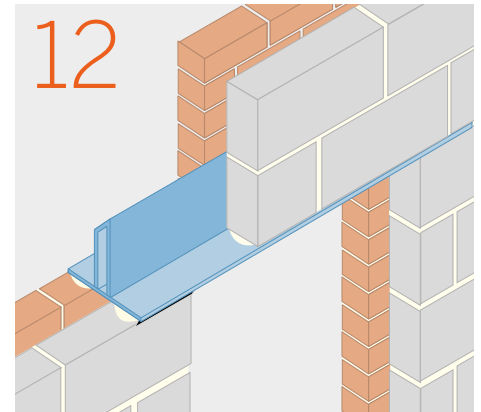
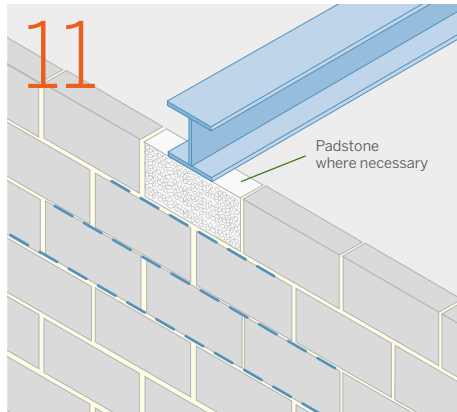

For clarity additional insulation not shown

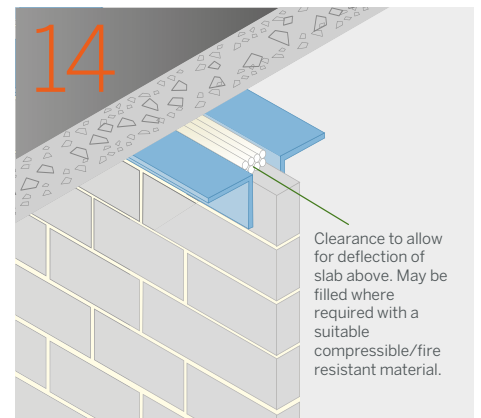
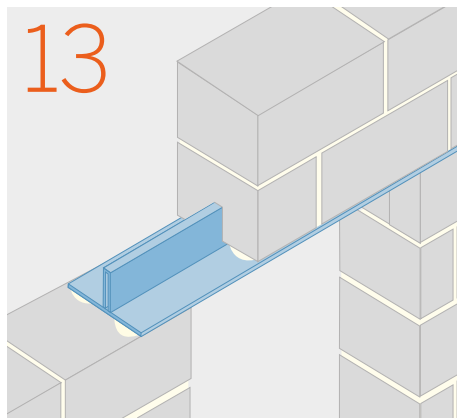

For clarity additional insulation not shown



# Internal walls

## Deflection head

Where a non-loadbearing internal wall is below a floor which is likely to experience deflection or thermal movement, provision should be made at the head of the wall to avoid such movement placing a load on the wall (drawing 14).

## Limiting dimensions

Limiting dimensions for non-loadbearing walls are given in Table 7 for various restraint conditions.

These figures have been developed by H+H and calculated in accordance with BS EN 1996-3 (Annex B).

**Table 7**

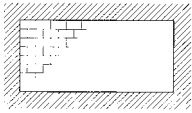
Limiting Dimensions for Internal Non-Loadbearing Walls								
Height (m)	Minimum Block Thickness (mm)* Length (m)							
	3	4	5	6	7	8	9	
 Walls restrained at both ends and top.	2.4	75	75	75	75	75	75	100
	2.7	75	75	75	175	75	100	100
	3.0	75	75	75	75	100	100	100
	3.3	75	75	75	100	100	100	100
	4.0	100	100	100	100	100	100	140
	6.0	100	140	140	140	140	140	140

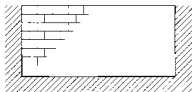
Height (m)	Minimum Block Thickness (mm)* Length (m)							
	3	4	5	6	7	8	9	
 Walls restrained at both ends.	2.4	75	100	100	140	140	140	140
	2.7	75	100	100	140	140	140	140
	3.0	75	100	100	140	140	150	200
	3.3	75	100	100	140	140	150	200
	4.0	100	100	140	140	140	200	200
	6.0	100	140	140	140	150	200	200

Wall block thickness (mm)	Maximum height (m) for panel of any length		
	Plastered**	Unplastered	
 Walls restrained at top.	100	3.75	3.0
	140	4.95	4.2
	150	5.25	4.5
	215	6.0	6.0

### Notes

These figures have been developed by H+H and calculated in accordance with BS EN 1996-3 (Annex B).

\* For plastered finishes, the block thickness shown may be reduced by the thickness of plaster.

\*\* 2 x 13mm of plaster assumed.

For further information please contact the H+H Technical Department. Consideration should be given where appropriate to the following factors:

- The effects of architectural features such as openings, chases etc.
- The accommodation of movement.
- Any temporary support which may be required prior to plastering.



# Movement control

## Accommodation of Movement

The risk of cracking in walls due to drying shrinkage and/or thermal movement can never be totally eliminated from any type of masonry and provisions such as movement joints and bed joint reinforcement (BJR) only act to reduce the risk of cracking. Similarly, when they are not used, the risk increases.

For all masonry work movement joints and/or BJR may need to be provided. These should be incorporated at the design stage and although PD 6697 (Recommendations for the design of masonry structures to BS EN 1996-1-1 and BS EN 1996-2) states that movement joints are not normally provided in internal walls of low rise housing (unless significantly long runs of wall are involved), the risk of cracking does however increase where:

- wall panels are shallow (length exceeds three times the height),
- lengths approach or exceed 6m,
- the ends of the wall are bonded-in,
- the mortar is over strong, or
- the work gets over-wet during construction.

## General Considerations

In the design of walls, movement should be accommodated by following the recommendations of BS EN 1996-2 and PD 6697, which can be summarised as follows.

With the exception of solid external walls or outer leaves, movement joints are not normally provided in drylined constructions as any cracking caused by drying shrinkage is not normally of any structural significance and will not be visible. However, where wall lengths exceed 6m, the following should be considered.

Block walls in excess of 6m should be designed as a series of panels separated by movement joints at maximum 6m centres. Alternatively, the wall panel can be reinforced either negating the need for or increasing the distance between movement joints. Movement joints should be avoided in separating walls because of concerns regarding sound transmission. Where the masonry is continuous at an internal or external corner, the first joint from the corner should be positioned within 3m of the corner (drawing 15).

Other areas needing particular attention are:

- Openings, or changes of wall height, thickness or direction.
- Shallow walls (where the length of a panel exceeds three times its height).
- Normally dissimilar materials should not be bonded together but should be separated by forming a vertical movement joint or by incorporating a horizontal slip plane.

Additionally, the following points of good practice should always be observed.

- 1 Overstrong mortars should be avoided. Generally, a Class M4 (Designation (iii) mix, (1:1:6 cement:lime:sand) is the strongest that should be used above DPC.
- 2 All blocks (as with other materials) should be protected, i.e. the normal good practice of covering the tops of partly-built walls:
  - i at the end of the day's work;
  - ii during wet weather;
  - iii once the wall has been completed but before the shell is weather-tight, thus preventing saturation of the wall. This will ensure minimal drying out movement.

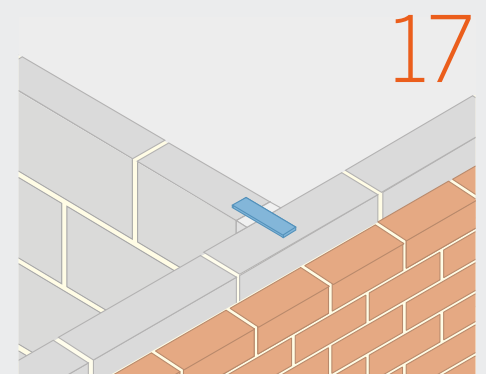
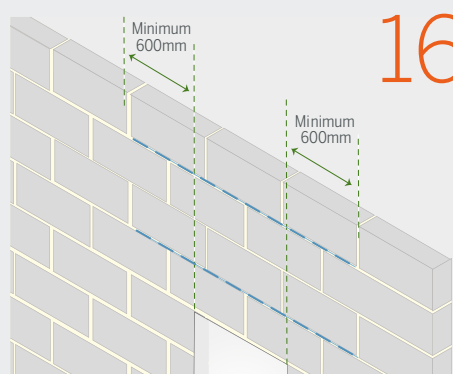
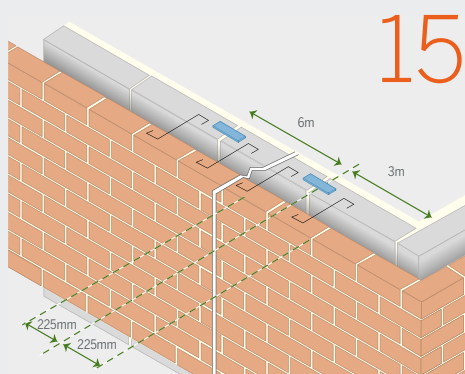

Flat strip ties only if designer requires continuity across the joint.



- 3 Use of bed joint reinforcement above and below openings (see section on bed joint reinforcement below) (drawing 16).

**Location of Movement Joints**

Where movement joints are required they are best positioned:

- At intersecting walls and columns (drawing 17).
- At changes of wall height or thickness, or where chases occur.
- To coincide with movement joints in adjacent elements of structure (floor or roof).
- At junctions of dissimilar materials.
- Where architectural or structural features create a 'weak' section i.e. at a junction with a structural column (drawings 18 + 19).

Note: Movement joints are not normally required below DPC level.

**Construction of Movement Joints**

Straight, un-bonded vertical joints are the most common type of movement joint, and can be formed by butting the blocks against both sides of a strip of rigid or flexible filler (such as polyethylene



foam). Additional cavity wall ties should be provided on either side of the joint. These should be located within 225mm each side of the joint and at a maximum of 300mm vertical centres. A flexible sealant may be applied as required to maintain air tightness.

Movement joints should normally be continuous through all surface finishes. Stop beads can be used to end the finish at either one or both edges of the joint. Alternatively, a proprietary type of cover strip can be used, or an architrave can be pinned to one edge of the joint (drawing 20).

Where design stability considerations require continuity across the joint, proprietary movement ties should be used. These should be set parallel to the plane of the wall. For traditional mortar joints proprietary types of slip-ties with one end sleeved are available. Cavity wall ties or ties with anchored ends, for example fish-tail ties, should not be used across movement joints since this would result in bonding of the joint, which would prevent accommodation of movement.

Movement ties specifically for thin joint blockwork are designed to fit into a 10mm wide movement joint and flex to allow for movement.

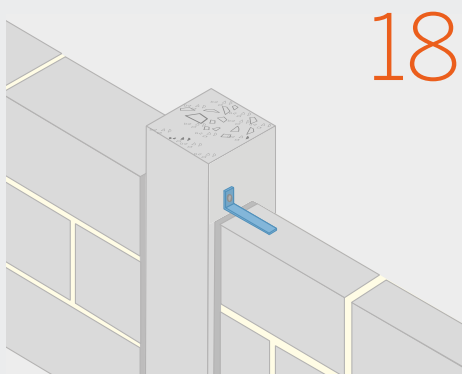

18

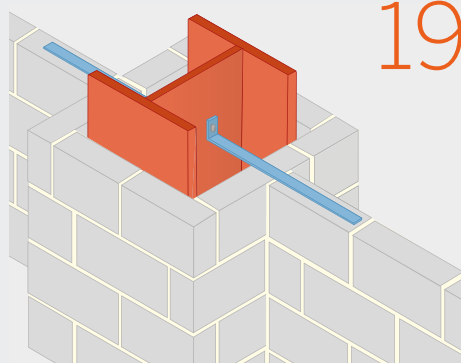

19

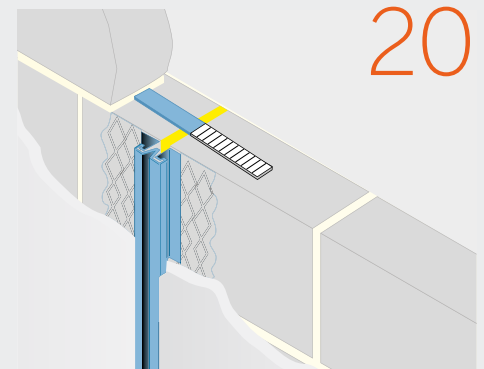

20

Restraints to be suitably fixed or built into structural members. Suitable dowels or 25mm x 3mm flat strip should be used with ends of each restraint built 100mm into wall to allow longitudinal movement.

One end of the sleeved or wrapped in a debonding material.

# Movement control

## Continued...

### Bed Joint Reinforcement

The use of bed joint reinforcement can reduce the risk of cracking caused by a concentration of stresses. Its use can also be extended so that where a movement joint would otherwise be advisable, but not desirable, e.g. where aesthetic or practical reasons do not allow, the wall panel may be reinforced through its length (drawing 21). This applies particularly to separating walls which should not contain a movement joint. For specific advice contact our Technical Department.

Reinforcement laid in horizontal bed joints is particularly appropriate for areas of high stress, for example at openings and under concentrated imposed loads.

Any such reinforcement should be of adequate length to distribute stresses to nearby movement joints or into adjacent areas of blockwork, extending, for example, at least 600mm into the adjacent blockwork each side of an opening (drawing 16).

Where a wall is supported by a floor or beam, which itself may be subject to deflection, the first two courses of the wall should be reinforced (drawing 22). In all cases, masonry-grade reinforcement should be used (plastering grade types are not suitable) and it should be installed in accordance with the manufacturer's recommendations.

In recognition of the fact that Thin Joint mortar is stronger than a traditional 1:1:6 (or its equivalent) mix, our recommendations for Thin Joint constructions is that bed joint reinforcement be generally included in every second course. This may be steel or proprietary GRP type.

### Wall Junctions

Normally walls should be bonded at returns and junctions unless a movement joint is required. However, where a section of wall has to be constructed after other work has been completed, the bonding can be replaced by a straight joint provided ties are built-in across the joint. This method of jointing is also preferable to bonding in situations where differential movement is likely to occur, for example, where sections of wall are constructed on different foundations or supports.

### Dissimilar materials

Where H+H aircrete blocks abut other materials (e.g. brickwork, steel etc.), differential movement can occur. Where dissimilar materials bear onto H+H aircrete blocks (e.g. cast in-situ concrete slabs, precast concrete beams or floor units, and lintels), the use of a separating layer or 'slip plane' at the bearing or bed joint reinforcement should be considered.

### Slip Plane

A slip plane is a sliding joint (a typical example would be a smooth DPC type material or building grade polythene) used to separate parts of the structure having different movement.

For example, the combined effects of drying shrinkage and the thermal movement of a concrete roof slab cast directly onto a block wall could cause cracking in the upper courses of the wall. The use of a slip plane between the top of the wall and the slab would help to prevent this. The most common use for slip planes is under the bearings of long lintels, precast concrete beams and in-situ concrete slabs.



21

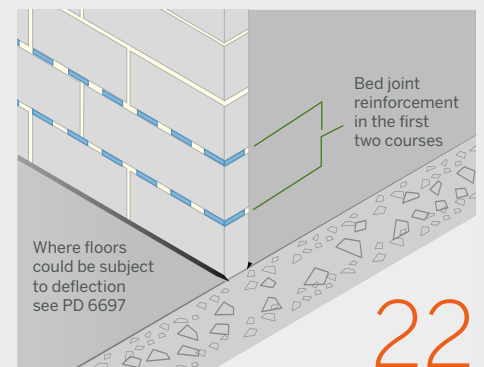

22

# Regulations (acoustics)

H+H UK products can easily achieve the requirements of National Building Regulations and Standards.

With excellent sound insulation qualities, which allow continued use of familiar construction methods with only minimal modifications to achieve the regulations for internal walls, floors and separating (party) walls and flanking walls.

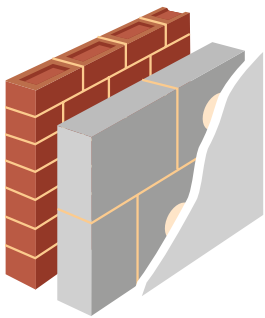

**Flanking Wall**  
100mm Any Celcon Block  
Any finish

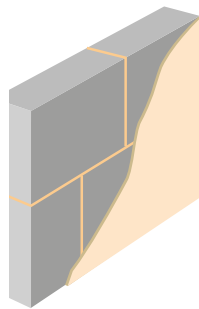

**Internal Partition Wall**  
100mm Celcon Block  
Standard Grade  
Any finish ( $R_w = 40\text{dB}$ )

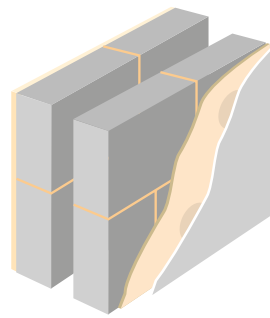

**Separating Wall**  
2 x 100mm (min)  
Celcon Standard or  
High Strength  
See Pages 22-23

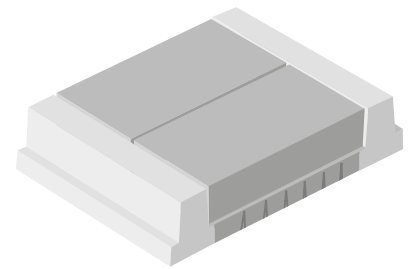

**Internal Beam and Block Floor**  
Minimum 40mm screed  
(sand/cement)  
**100mm Celcon Block Standard  
Grade 440 x 215mm**  
12.5mm plasterboard ceiling  
( $R_w = 40\text{dB}$ )



# Acoustic compliance

## The routes to compliance

Compliance to Approved document E of the Building Regulations is achieved via one of two routes:

### 1) Robust Details:

When used in accordance with the rules and procedures of Robust Details Limited ([www.robustdetails.com](http://www.robustdetails.com)). They are construction solutions that provide an alternative to Pre-Completion Testing (PCT) as a method of complying with Part E (resistance to the passage of sound) of the Building Regulations for England and Wales for new build houses, flats and apartments.

### 2) Pre-Completion Testing (PCT):

To ensure achievement of the specified performance requirements. Pre-Completion Testing has been introduced to ensure the sound insulation of homes and rooms for residential purposes (both newly built and conversions) meet the performance standards of Part E1.

### Apartments – Separating Floors:

The aircrete Robust Details (E-WM-6, 10, 13, 15, 23, 24 and 30) are equally suitable for use in apartments, when used in combination with one of the compatible separating floor constructions. Within the current RD handbook reference should be made to the following separating floors (E-FC-4, 5, 8 and 9) to achieve full Robust Detail compliance.

### Rooms for Residential Purposes:

Rooms for residential purposes (such as hotels and hostels) are subject to the requirements of Part E of the Building Regulations but the use of Robust Details is not recognised as a suitable form of demonstrating compliance. Consequently, pre completion acoustic testing is needed on site. H+H aircrete can also be used in separating and flanking walls in such builds and suitable constructions for this purpose are shown on adjacent page.

### Schools Solutions:

To satisfy Requirement E4, refer to Building Bulletin 93 Acoustic Design of Schools produced by the DfE and published by the Stationery Office. Due to the complexity of the design process, the document states 'in all but the simplest cases, it is advisable to appoint a suitably qualified acoustic consultant' who would normally be a corporate member of The Institute of Acoustics ([www.ioa.org.uk](http://www.ioa.org.uk)).

H+H aircrete offers the ability to construct a variety of masonry solutions for educational buildings to satisfy the performance levels required.

For further information relating to the use of H+H products and school construction please contact H+H's technical department.



**Separating Walls - solid construction (43dB)**

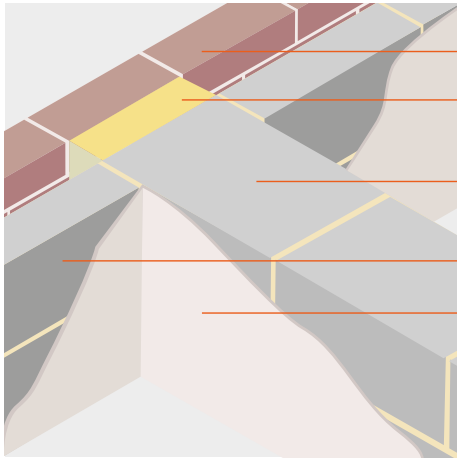

- Masonry outer leaf
- Cavity closer
- Separating wall – 215mm (min) Standard or High Strength Grade
- Flanking wall
- Plaster finish

**Separating Walls - cavity construction (43dB)**

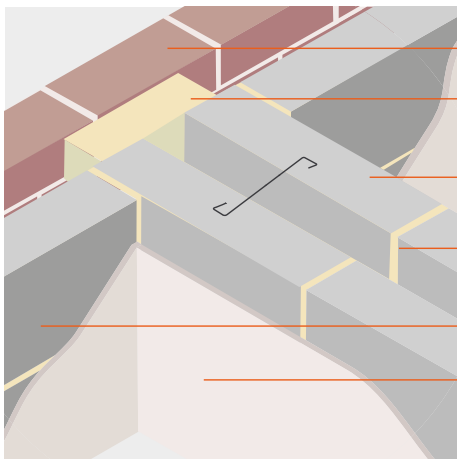

- Masonry outer leaf
- Cavity closer
- Separating wall – 100mm (min) Standard or High Strength Grade
- Minimum 75mm cavity (may be clear or fully insulated with mineral wool with a maximum density of 40kg (m<sup>3</sup>))
- Flanking wall
- Plaster or plasterboard on dabs

**Flanking Walls**

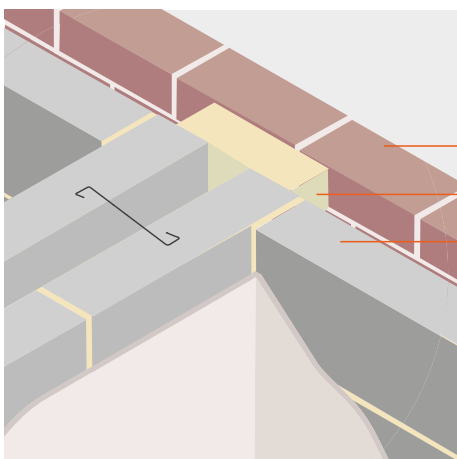

- Masonry outer leaf
- Cavity closer
- Flanking wall – Any 100mm (min) H+H aircrete, any Finish

# Robust Details for acoustic performance

## What is a Robust Detail?

A Robust Detail, for Part E of Building Regulations, is a separating wall or floor construction which has been assessed and approved by Robust Details Limited (RDL).

In order to be approved, each Robust Detail must:

- Be capable of consistently exceeding the performance standards given in Approved Document E to the Building Regulations for England and Wales
- Be practicable to build
- Be reasonably tolerant to workmanship

Robust Detail designs are pre-tested to higher standards than those required by Approved Document E of the Building Regulations before being approved by Robust Details Limited (RDL). Therefore, if you register your build with RDL and build in compliance with Robust Details, you will not have to carry out pre-completion sound testing.

### E-WM-6 Separating wall – cavity masonry

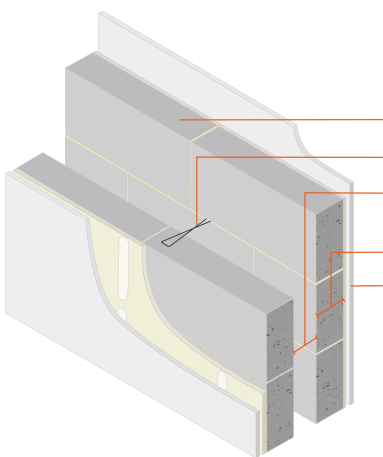

#### Aircrete blocks

Render and gypsum-based board on dabs

#### Block type

100mm H+H Standard or High Strength Grades

#### Wall ties

Approved Document E Tie Type A

#### Cavity width

75mm (min) (may be clear or fully insulated with mineral wool with a maximum density of 40 kg/m<sup>2</sup>)

#### Block thickness

100mm (min), each leaf

#### Wall finish

Gypsum-based board (nominal 8 kg/m<sup>2</sup> mounted on dabs on cement:sand render (nominal 8mm) with scratch finish. Render mix must not be stronger than 1:1:6 and not stronger than background

#### External (flanking) wall

Masonry (both leaves) with 50mm (min) cavity – clear, fully filled or partially filled with insulation

#### Notes

All RDL information provided here is accurate at the time of going to press.

For details of any changes and to keep up to date with current assessments visit: [www.robustdetails.com](http://www.robustdetails.com)

**E-WM-10 & 13** Separating wall – cavity masonry (thin joint)

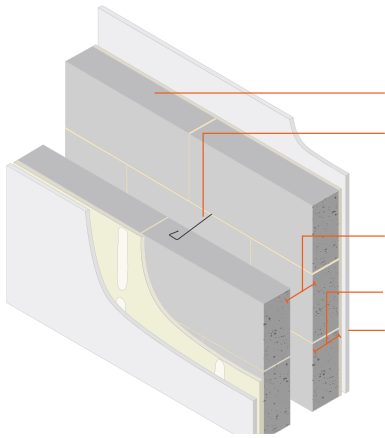

**Aircrete thin joint system**

Render and gypsum-based board on dabs

<b>Block type</b>	100mm H+H Standard or High Strength Grades
<b>Wall ties</b>	For <b>E-WM-10</b> , wall ties must be Ancon Building Products Staifix HRT4 or Clan PWT4 installed at not more than 2.5 ties per square metre For <b>E-WM-13</b> , no wall ties are to be inserted in the separating wall (this RD can give up to 3 credits in the CfSH)
<b>Cavity width</b>	75mm (min) (may be clear or fully insulated with mineral wool with a maximum density of 40 kg/m <sup>3</sup> )
<b>Block thickness</b>	100mm (min), each leaf
<b>Wall finish</b>	Gypsum-based board (nominal 8 kg/m <sup>2</sup> ) mounted on dabs on cement:sand render (nominal 8mm) with scratch finish. Render mix must not be stronger than 1:1:6 and not stronger than background
<b>External (flanking) wall</b>	Masonry (both leaves) with 50mm (min) cavity – clear, fully filled or partially filled with insulation

**E-WM-15** Separating wall – cavity masonry

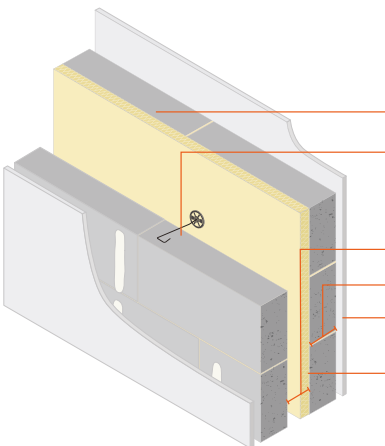

**Aircrete blocks**

35mm (minimum) Saint Gobain-Isover RD35 Acoustic Batt. Gypsum-based board (nominal 9.8 kg/m<sup>2</sup>) on dabs (no render parge coat)

<b>Block type</b>	100mm H+H Standard or High Strength Grades
<b>Wall ties</b>	Insulation retaining wall ties to Approved Document E 'Tie type A'
<b>Cavity width</b>	75mm (min), leaf-to-leaf
<b>Block thickness</b>	100mm (min), each leaf
<b>Wall finish</b>	Gypsum-based board (nominal 9.8 kg/m <sup>2</sup> mounted on dabs)
<b>Insulation</b>	35mm (min) Isover RD35 mineral wall acoustic batt
<b>External (flanking) wall</b>	Masonry (both leaves) with 50mm (min) cavity – clear, fully filled or partially filled with insulation

**E-WM-23, 24 & 30** Separating wall – traditional or thin joint (these RDs can give up to 3 credits in the CfSH)

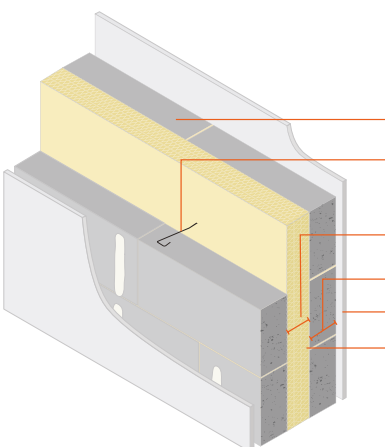

**Aircrete blocks**

100mm (minimum) Superglass Party Wall Roll (E-WM-23 only)  
100mm (minimum) Isover RD Party Wall Roll (E-WM-24 only)  
100mm (minimum) Knauf Supafil Party Wall (E-WM-30 only)  
Gypsum-based board (nominal 8.0 kg/m<sup>2</sup>) on dabs (no render parge coat)

<b>Block type</b>	H+H Standard or High Strength Grades
<b>Wall ties</b>	Ties to Approved Document E 'Tie type A' For thin joint, wall ties must be Ancon Building products Staifix HRT4 or Clan PWT4
<b>Cavity width</b>	100mm (min) leaf-to-leaf
<b>Block thickness</b>	100mm (min) each leaf
<b>Wall finish</b>	Gypsum-based board (nominal 8.0 kg/m <sup>2</sup> ) mounted on dabs
<b>Insulation</b>	Superglass Party Wall Roll (E-WM-23 only) Isover RD Party Wall Roll (E-WM-24 only) Knauf Supafil Party Wall Insulation (E-WM-30 only)
<b>External (flanking) wall</b>	Masonry (both leaves) with 50mm (min) cavity – clear, fully filled or partially filled with insulation

# Fire resistance

## Fire Resistance

All H+H products have excellent resistance to fire. Extensive use has proved their capability in real fires, not only as fire-break walls, but also as protective cladding for other forms of construction, such as steel frame.

BBA certificate 01-3816 confirms that H+H aircrete is classified as non combustible (as defined in the National Building Regulations) and have a reaction to fire of Class A1 to BS EN 13501-1.1.

## Fire Resistance Ratings

A 100mm H+H aircrete block wall is fire resistant up to 4 hours in non loadbearing situations and 2 hours (Standard or Higher Strength Grades) in loadbearing situations.

Where H+H aircrete is used in cavity wall constructions, the thicknesses shown below may be reduced. Contact the Technical Services Department for further advice.

Designers may also use BS EN 1996-1-2 (Eurocode 6: Part 1-2).

## Fire Resistance – Solid Partition Walls

A solid partition wall means there is no build up of combustible material in the cavity, which can generate a flue effect in stud partitions.

## Fire Resistance – Beam and Block Floors

When finished with 13mm plasterboard, internal beam and block floor systems provide one hour's fire resistance, meeting the requirements of the National Regulations & Standards.

Table 8

Examples of Fire resistance from BS EN 1996-1-2								
Fire Resistance (hours)	Minimum block thickness excluding finishes*							
	Loadbearing wall up to				Non-Loadbearing wall up to			
	1	2	3	4	1	2	3	4
Solar Grade range (mm)	100	215	215	215	100	100	100	100
Standard and Higher Strength Grade ranges (mm)	100	100	140	215	75	75	75	100

\* Block sizes indicated may not be stocked items.





# CDM regulations

The Health and Safety Executive (HSE) deals with all aspects of construction work in Great Britain. This includes ensuring building sites are adhering to safety procedure such as manual handling.

The Construction (Design and Management) Regulations (CDM) 2015 place specific duties directly on designers:

- **To eliminate hazards where foreseeable**
- **Eliminate hazards which may give rise to risks**
- **To reduce risks from any remaining hazards**

## Block Weights

The Construction Industry Advisory Committee (CONIAC) guidance suggests that repetitive handling of blocks over 20kg can increase risk of injury therefore when designing or specifying blocks, the lightest block that fulfills the performance criteria should be chosen.

Celcon Block weights can be found on individual product data sheets or within our Products and Applications guide.

## Aircrete Solutions

The cellular structure of aircrete ensures a product that is both strong and lightweight, thus providing significant productivity and health and safety advantages.

**Table 9**

Maximum block thickness (mm)* within our product range to comply with CDM Regulations				
Product format	Solar	Standard	High Strength	Super Strength
440 x 215	215	275	200	200
630 x 215	215	200	150	150
630 x 140	-	300	215	215
630 x 250	140	140	140	140

\* Based on block handling weights at typical moisture content when laid. Some manufacturer's quote data which does not include this allowance. Not all products listed are stocked items.

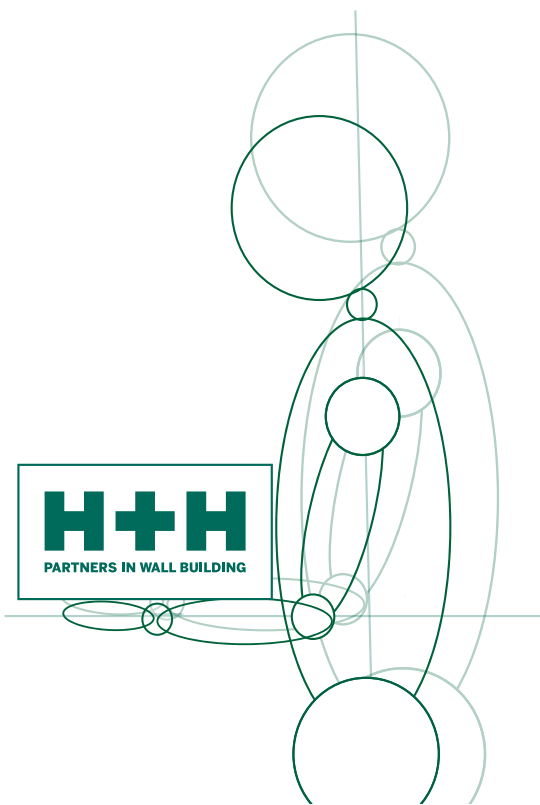

# Good site practice

## Site Practice

All site work should be carried out in accordance with the recommendations of BS 8000-3.

## Storage

H+H aircrete is fully cured on dispatch and ready for use as soon as it has cooled to ambient temperature; this is normally within two days of manufacture. Blocks should be unloaded on to a dry, level surface, and should be covered to protect them from severe weather. Blocks that have become wet should be allowed to dry out before use, to reduce the risk of drying shrinkage in the completed blockwork. As a general rule, on hard standing, packs with or without pallets should be stored no more than three high. On uneven ground and on site, stacking should normally be restricted to a maximum of two packs high.

For further guidance see the Health & Safety Data on page 25.

## Mortars

The use of over-strong mortars should be avoided (with general mortars, the mortar should not be stronger than the block). Lower mortar strengths enhance the ability to accommodate movement (see PD 6697). As a general rule, cement:lime:sand mortars give a stronger bond than plasticised mortars of a similar compressive strength.

For more information on lime-based mortars, see the Mortar Industry Association's Datasheets 11 and 18 ([www.mortar.org.uk](http://www.mortar.org.uk)).

Recommended Mortar Types Class M4 Mortar is the strongest that should be used with traditional blockwork above ground level, and is generally suitable, provided structural considerations do not demand a stronger mix and the masonry is protected during construction from saturation and freezing. Below ground level, mortars of M6 (1:½:4

cement:lime:sand) particularly where there is a risk of freeze/thaw, or M4 may be used, according to soil conditions.

Under very dry conditions, aircrete should not be wetted but the consistency of the mortar should be adjusted to suit the suction. Admixtures intended as a precaution against frost damage should not be used, since they can give rise to adverse effects on the hydration of cement, and have other undesirable effects.

Pre-mix or ready to use mortars should comply with BS EN 998-2.

For information on Celfix mortar for use with the H+H Thin-Joint system, please see our website [www.hhcelcon.co.uk](http://www.hhcelcon.co.uk) where the full range of our brochures are available to download.

Table 10

Recommended prescribed and designed mortar types			
Type of Mortar	Proportion by volume	Mortar Strength	
		Designation	Class
Celfix (thin layer) mortar	-	-	M10
Cement:lime:sand	1:½:4-4½*	(ii)*	M6*
Cement:lime:sand	1:1:5-6	(iii)	M4
Cement:sand with plasticiser	1:6	(iii)	M4
Masonry cement:sand	1:4-5	(iii)	M4
Cement:lime:sand	1:2:9	(iv)	M2

\* For use below DPC

NB: When the sand proportion is given as, for example, 5 to 6, the lower figure should be used with sands containing a higher proportion of fines, whilst the highest figure should be used with sands containing a lower proportion of fines.



### Block Laying

When laying aircrete blocks, the following principles should be observed:

- 1 A regular bond pattern should be maintained based on a minimum overlap of a quarter of a block, but never less than 75mm.
- 2 Blockwork should be set out to ensure that wherever possible all lintels bear upon full blocks, not onto a short length of cut block. The bearing should normally be at least 150mm in length.
- 3 Cut blocks and Coursing Units should always be used for irregular or non-standard spaces; bricks, mortar or other dissimilar materials should be avoided.
- 4 Blocks should be laid on a full bed of mortar, with 10mm (2mm for Thin-Joint System) thick vertical and horizontal joints. It is essential for acoustic performance that all joints, in particular, within separating walls are fully filled.
- 5 When walls are to be externally rendered or internally plastered, the joints should be left recessed (except where Thin layer masonry is used).
- 6 Any movement joints and/or bed joint reinforcement should be built-in as work proceeds.
- 7 Blockwork should be protected from adverse weather during and immediately after laying (see 'BRE Good Building Guide 34')

### Accuracy

Construction tolerances should not exceed the permissible values set out in BS 8000-3. For further guidance on accuracy, see BS 5606 Code of practice for accuracy in building and NHBC guidance.

### Workability

Site wastage can be kept to a minimum using aircrete, because special shapes and infill pieces can be easily cut with hand tools. Percussive power tools are not necessary. One of the key advantages of walls built using H+H aircrete is that it is easy to place services such as electric cables, water pipes etc, wherever required. The physical nature of the material allows quick and simple cutting and chasing.

Holes can be made with a normal drill. Chasing can be carried out with a chisel or similar wood working tools. The depth of vertical chases should be limited to one-third of the wall thickness, and horizontal chases to one-sixth of the wall thickness. Back-to-back chasing in walls should only be carried out with the designer's approval and should never occur in walls where acoustic performance is important.

### Beam and Block Floors

#### Provision for Services

The forming of service holes can be simply achieved by leaving out blocks from the floor. The voids around pipes should then be made good with insitu concrete.

#### Site work – Beam and Block Floors

All joints between blocks and the beams must not exceed 5mm and must be grouted before the floor is finished and used. The grout should be a mix of cement/sand with sufficient water added to produce a slurry of suitable consistency for brushing or pouring depending on the beam profile. For further details see the H+H BBA certificate. Planks or boards should be used as spreaders during installation and at all times until the floor is grouted. The floor should not be overloaded during construction.



# External applied finishes



## External Applied Finishes

As a consequence of the different cutting processes used at different factories, some H+H Celcon Blocks are manufactured with scratched surfaces whilst most are plain faced. The scratched surface is not produced to provide a key for render and is normally inadequate for that purpose. Apart from appearance, blocks supplied from different factories will have identical physical properties. These recommendations, therefore, apply equally to all H+H aircrete products, whether plain faced or scratched.

Externally rendered H+H aircrete as an outer leaf of a cavity wall, or as a solid wall where exposure conditions allow, are suitable constructions. The choice of aircrete grade and render specification should reflect the exposure conditions and whether the cavity contains insulation or not (see Table 11). Work should comply with BS EN13914 'Design, preparation and application of external rendering and internal plastering' Part 1: External Rendering.

## Blockwork

### Movement Joints:

PD6697-Recommendations for the design of masonry structures to BS EN 1996-1-1 and BS EN 1996-2 advises that for all masonry work, movement joints may need to be provided. For further information please see Movement Control section on page 16. The general requirement for concrete blocks is that a movement joint should be provided within 3m from corners and at 6m centres thereafter.

In addition, it is advisable for a rendered wall that bed joint reinforcement is incorporated above and below openings. Specific recommendations will depend on the circumstances, and each situation should be assessed on its own merits, please consult our Technical Services Department for further guidance if required.

Table 11

Appropriate Grade of H+H aircrete for render application				
External Product Grade	Exposure conditions (up to and including)	Cavity Wall		Solid Wall
		Clear or partially filled cavity	Fully filled cavity	
Solar	Sheltered/Moderate	*	*	✓
	Severe	*	*	*
	Very severe	*	*	PD6697 recommends impervious cladding to solid walls in severe exposures
Standard High or Super Strength	Sheltered/Moderate	✓	✓	✓
	Severe	✓	*	*
	Very severe	*	*	PD6697 recommends impervious cladding to solid walls in severe exposures

✓ Directly bonded render suitable, NB: Where provision for movement has NOT been made in the aircrete wall (i.e. vertical movement joints and/or bed joint reinforcement), consideration should be given to the use of a reinforced render system as detailed below.

\* Traditional renders should be applied via metal lathing as a reinforced render system. Some proprietary renders may be suitable for direct application subject to confirmation by manufacturer.

**Mortar:**

The use of over-strong mortars should be avoided as lower mortar strengths enhance the ability of the wall to accommodate movement.

Recommended mortar mixes are as given for render mixes below. Generally, lime based mixes are preferable as these give a better bond than can be obtained with air-entrained mortars of similar compressive strength. In external situations, lime based mortars can also give higher resistance to rain penetration.

For thin joint constructions, H+H recommends that only H+H Celfix mortar is used in conjunction with our products.

**Site Practice:**

All blocks (as with other materials) should be protected. Keeping the blocks dry will ensure minimal drying out movement.

**Render**

The following guidance covers the application of traditional renders when applied direct to the aircrete walls.

Where H+H aircrete is used for a solid wall, or for the external leaf of a cavity wall, the external render should be terminated at DPC level, unless a proprietary render approved for such an application is used. A bituminous paint suitable for external use, or similar surface coating, applied to exposed aircrete from 150mm below soil level up to DPC is good practice (see drawings 23 and 24).

Any movement joints present in the wall should be continued through the render finish. Proprietary types of external-grade stop bead incorporating a cover strip are available for this purpose. Alternatively, two stop beads can be placed back to back with a flexible sealant applied between the two.

**Traditional Sand: Cement** mixes should not be stronger than the backgrounds onto which they are applied. Similarly, each coat of render should be weaker than the preceding one. This requirement is normally met by using the same mix proportions for each coat and ensuring that successive coats are significantly thinner. A Class M4, or equivalent, is the strongest mix recommended for use for direct application on to aircrete walls. Recommended mix proportions (by volume) are given in Table 12.

**Sand** used for rendering should be clean, sharp, well graded and comply with the requirements of BS EN 13139:2002 'Aggregates for mortar'. Traditionally, the coarsest and sharpest sand that can be conveniently handled should be used for undercoats. Sand normally used for brick/block laying mortar is unlikely to be suitable due to the high proportion of finer material.

**Number and thickness of coats** will depend on exposure and method of application. Generally two-coat work is suitable for 'sheltered' and 'moderate' exposure conditions with the final coat being about half the thickness of the undercoat.

Three coats are recommended for 'severe' and 'very severe' exposure conditions (and for renders applied over metal lathing or mesh).

Single coat work should be restricted to proprietary systems designed to be used in this way.

**Table 12**

Recommended prescribed and designed mortar types			
Type of Mortar	Mortar Strength		
	Proportion by volume	Designation	Class
Cement:lime:sand	1:1:6	(iii)	M4
Cement:sand with plasticiser	1:6	(iii)	M4
Masonry cement:sand	1:5	(iii)	M4

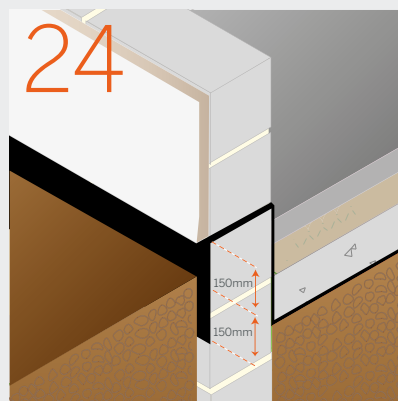
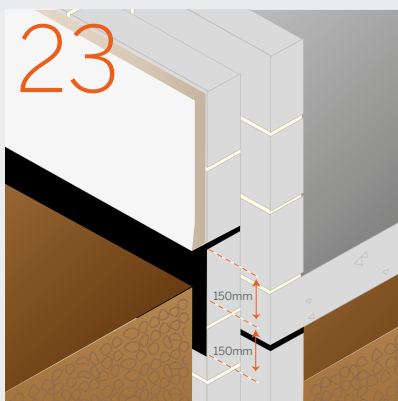

# External applied finishes

Continued...



## Surface Preparation

The background should be adequately prepared. The wall should be cleaned of any dust, loose particles and contamination, which may have occurred during construction. In extreme cases of bad site storage or wet conditions where fungi or algae may have formed on the wall, the surface must first be treated with a fungicide, applied in accordance with the manufacturer's instructions.

As recommended in BS8000 Part 3, we would suggest that mortar joints should be raked by 15mm as work proceeds on all masonry to be rendered in order to provide a good key. For walls built with thin layer mortar joints (which cannot be raked), we would suggest the use of a surface treatment, as detailed below for high suction situations, to improve the key for rendering. Alternatively a reinforced render system may be used.

In order to control high suction, which may exist particularly during warmer weather, and to improve the key for subsequent coats, BS EN13914 Part 1 suggests the use of a surface treatment such as a 'stipple' coat or 'spatterdash'. Alternatively, a proprietary surface treatment, may be used and applied in accordance with the manufacturers recommendations.

The stipple or spatterdash should consist of 1 part cement to 2 parts sharp sand mixed to a thick creamy consistency with water and a bonding agent suitable for external use (eg SBR, EVA or an acrylic emulsion).

For a stipple coat, the slurry should be vigorously brushed onto the wall to wet the surface thoroughly and then immediately stippled with a freshly loaded brush to provide a stipple texture. Alternatively, spatterdash is applied by throwing the mixture onto the wall to give a rough texture similar to the stipple effect.

The treated surface should be protected from drying out for the first day and then allowed to dry and harden for another day or two before the rendering undercoat is applied. Any applied surface treatment should be checked to ensure that it is firmly bonded to the background before the undercoat is applied.

The use of a 'scratch coat' (normally consisting of a 3-4mm, heavily scratched first coat of the same mix proportions as subsequent coats) to control suction is not recommended for external renders as subsequent coats will invariably be thicker, and therefore stronger.

## Application

Undercoats should be a nominal 12mm ( $\pm 4$ mm to allow for variations in the wall surface) and should be combed or scratched. This not only provides a key for the following coat but also helps to reduce the development of the 'sheet' strength of the render. Scratching or combing should be in wavy lines and not straight, horizontal lines (which can concentrate stresses in one direction leading to subsequent vertical cracking).

Newly applied rendering should be kept damp for the first day or two and the next coat should not be applied until the undercoat has adequately dried for a further two or three days. It is necessary for the drying to take place to provide suction for the next coat. For three-coat work, the second coat should be approximately 9mm.

Final Coats should normally be approximately 6mm thick. Where a proprietary type of finish is used, it should be applied strictly in accordance with the manufacturer's instructions. Otherwise, the render should be finished with a wooden float (the use of steel trowel or float will result in a smooth dense surface which is liable to crazing) to produce the characteristic sandpaper texture, or textured as required.

Dry dash and roughcast finishes traditionally require a strong render mix and are therefore not deemed to be suitable for application on to aircrete. However, such finishes may be used provided a 1:1:6 (or equivalent strength) mix is not exceeded or a reinforced render system is adopted.

Decorative finishes should not be applied until the top coat has dried out, but dry dash and roughcast is part of the top coat and should be applied whilst the top coat is in a suitable state to receive the aggregate to allow adequate embedment.

## Admixtures

Providing the work and materials comply as above, the use of additives should not be necessary. Some tradesmen, based on local practice and experience, add water-retaining admixtures (to prevent rendering from losing water too quickly) or waterproofing admixtures (to reduce suction) in undercoats. However, BS EN13914 advises that certain types of admixture may have an adverse affect on adhesion between subsequent render layers and paint, we would therefore advise caution on their use.

## Proprietary Systems

Proprietary renders should be applied strictly in accordance with the manufacturers' recommendations with regards to suitability and preparation of backgrounds on to which they are applied.

Depending on the supplier, some use only approved installers whilst others will also supply their materials for others to apply and offer a site advice service.

Reinforced render systems incorporating metal lathing or proprietary meshes (e.g. Bekaert Stucanet, Expamet Riblath) should be installed in accordance with the manufacturer's recommendations. This should include guidance on fixings, laps, provision of movement joints and suitable mixes (which may need to be stronger than that previously discussed).

## External Wall Insulation Systems

External wall insulation systems are becoming more popular to either improve the thermal performance of existing buildings or to provide high levels of thermal performance to new build. Many such systems exist and these have been successfully applied to H+H solid wall products to obtain a U-value of 0.15W/m<sup>2</sup>K or less in a cost effective construction. The manufacturer of the system should be consulted and it is recommended that the system is confirmed by independent certification. The system usually consists of a rigid insulation board fixed mechanically or bonded to the aircrete and finished with a render system onto a mesh.



# Internal applied finishes

## Plaster Mixes

Most types of plaster, can be applied to H+H aircrete. Choice of plaster type and application should be made with regard to guidance given in BS EN13914 'Design, preparation and application of external rendering and internal plastering' Part 2: Internal plastering and PD6697 (see also FPDC Advisory Note No 1 'The application of plaster to aircrete block walls').

Traditional sand:cement (dense) plasters should not be stronger than the backgrounds onto which they are applied. An M4 or equivalent, is the strongest mix recommended for use for direct application on to aircrete walls. Recommended mix proportions (by volume) for M4 are given in Table 13.

## Gypsum (lightweight) plasters

The manufacturer's recommendations should be followed as to the appropriateness of their plasters for application onto aircrete. Portland cement and gypsum plasters should never be used in the same mix nor allowed to contaminate each other at any stage of the mixing or gauging of materials.

**The total thickness** of plaster is normally 13mm when applied to blockwork. This excludes any 'dubbing out' which may be necessary when walls have been built out of plumb or alignment, or where architectural features require localised thickening of the plaster finish.

## Surface Preparation

The following guidance covers the application of traditional dense plaster when applied direct to the aircrete walls. Proprietary and pre-mixed plasters should be applied in accordance with the manufacturer's recommendations.

As recommended in PD6697, we would suggest that mortar joints should be raked by 15mm as work proceeds on all masonry to be plastered or rendered in order to provide a good key. For walls built with thin layer mortar joints (which cannot be raked), we would suggest the use of a PVA bonding coat, as detailed below, to improve the bond for plastering. Walls should be cleaned of any dust, loose particles and contamination, which may have occurred during construction. In extreme cases of bad site storage or wet conditions where fungi or algae may have formed on the wall, the surface must first be treated with a fungicide, applied in accordance with the manufacturer's instructions.

Any movement joints present in the wall should be continued through the plaster finish. Proprietary types of movement beads incorporating a cover strip are available for this purpose. Alternatively, stop beads abutting adjoining work can be used to provide a break in the plaster.

Table 13

Recommended prescribed M4 mortar types	
Type of Mortar	Proportion by volume
Cement:lime:plastering sand	1:1:6
Cement:plastering sand with plasticiser	1:6
Masonry cement:plastering sand	1:5





H+H aircrete, under normal conditions, has moderate to high suction. In very dry conditions, it may be necessary to control high suction by dampening the wall using a stock brush or fine spray immediately before plastering to balance the blocks' initial suction. This must be carried out in a controlled fashion and on relatively small areas at a time. Excessive wetting must be avoided. Alternatively, a PVA bonding coat can be applied in accordance with the manufacturer's recommendations. These are typically applied diluted in two coats, with the first acting as a primer (which is allowed to dry) and the plaster is applied to the second coat whilst it is still tacky.

### Dry Lining

Both standard plasterboard and laminated thermal boards can be fixed by bonding directly to the blockwork using proprietary dabs or adhesive, or attached to proprietary metal furring systems.

### Direct Bonding

Plasterboard can be directly bonded to the background using plaster dabs in accordance with the instructions of the board manufacturer; those boards which have a layer of bonded insulation should be fixed by means of a suitable adhesive. Selection of a suitable adhesive, and the most appropriate method of application should be made in accordance with the board manufacturer's instructions.

Secondary nailing using proprietary nails and plugs is also necessary to ensure that laminated linings remain attached to the blockwork in the event of fire.

### Battening

Plasterboard can also be fixed by means of a timber or a proprietary metal furring system, which should be spaced in accordance with manufacturer's instructions. The method of fixing the framing to aircrete is covered under 'Fixing'; (see drawings 25 and 26 on page 35) (see also plasterboard manufacturer's data).

### Internal Tiling

Traditionally, internal ceramic tiling is applied to blockwork which has previously received a rendered or plastered finish. A period of six weeks must be allowed between the completion of the blockwork and the start of the rendering or plastering, and a further two weeks must be allowed before the tiling commences. For further information, see BS 5385-1.

Proprietary adhesives are available which permit tiling to be carried out sooner on blockwork which is sufficiently plumb and accurate. However, this method is not appropriate for every situation and advice should be sought from the manufacturers of the tiles and the adhesive.

Generally, tiles should comply with BS EN 14411.

Technical specifications (materials and methods) for ceramic wall tiling can be obtained from The Tile Association: [www.tiles.org.uk](http://www.tiles.org.uk)

BRE Defect Action Sheet 137 gives general advice to avoid problems in internal tiling.

### Tiling Rendered and Plastered Walls

An undercoat of cement:sand (dense) plaster provides a stronger background for tiling than lightweight plaster and should be used wherever possible. See the Tile Association guidance.

Preparation: cement and sand render is the preferred background for large areas of blockwork which are intended to receive a tiled finish, but the blockwork should be allowed to dry out for at least six weeks before rendering. On Solar Grade blockwork the render should be reinforced, with welded wire mesh secured to the blockwork. For further guidance see BS 5385-1. The most suitable mix for H+H Standard Grade and Higher Strength Grade block walls is 1:4 cement:sand (by volume); Solar Grade block walls, appropriate mixes include 1:5 masonry cement:sand, or 1:6 cement:sand plus a plasticiser.

Application: rendering should be left with a wood float finish (see BS 5385-1) and should be completed at least 14 days before the tiling begins; the surface should be dry to receive the tiling. When conditions of service are damp or wet, a flexible, water-resistant adhesive should be used with a solid-bed technique (see BS 5385-4).

Large areas of tiling should be divided into bays of 3-4.5m<sup>2</sup>. Movement joints will be required at edges of tiled areas and at junctions of walls, floors and ceilings. Movement joints in the wall should extend completely through the tiling, bedding and rendering.

# Internal applied finishes

Continued...



## Decorative Finishes

Aircrete can be left unfinished or finished with one of many surface treatments, other than conventional render, plaster and tiling.

## Tiling Unrendered Walls (internal)

Provided the walls have been well built to the required standards for plumb and accuracy for the recommended thickness of the bedding material, tiles can be fixed direct to block walls. The wall surface should be free from dust, oil and other forms of contamination, and should be dry or almost dry; the blockwork should be completed at least one month before the tiling begins.

The tiles should be fixed with a proprietary adhesive, using the solid-bed technique. A thin-bed or a thick-bed adhesive may be used depending on the flatness of the wall. For general guidance on internal tiling see BRE Defect Action Sheet 137.

The selection of a suitable adhesive will depend on the background to which the tiles are to be fixed, and it is important to follow the particular adhesive manufacturer's instructions. BS 5385-1 gives advice on the choice of adhesives available.

## Natural or Painted Finishes

Where blockwork is protected from regular contact or is out of reach, the most economical finish is for it to be left exposed or painted. A painted wall will often be perfectly satisfactory in areas with limited access, for example in plant rooms.

It should be noted that although all H+H blocks are suitable to receive a paint finish, we do not sell any of our products as being 'Paint Grade' or 'Fair Face'. Where it is intended to have a painted finish we suggest the following is considered.

Due to the manufacturing process it is possible that occasional 'pock' marks may be visible on the face of the blocks (as the result of a wire cutting through one of the larger air bubbles). It is also possible that edges may become chipped whilst the blocks are moved around site – although not an issue with traditional applied finishes, this may be an issue with fair face work.

Given the aforementioned, we would suggest that where our blocks are intended to be finished with paint only or left unfinished, that a sample panel is built to determine the acceptability of the surface of the blockwork panel for the project in hand.

Paints of most types can be applied direct to the surface of the blocks. After normal preparatory work, the paint should be applied following the manufacturer's specific recommendations. A mist coat (or sealer) plus two full coats of trade emulsion is generally adequate to provide an economical finish.

## Textured Finishes

There are also many proprietary surface treatments which can be used on aircrete blockwork, either directly or on a rendered background. These should always be applied in accordance with the relevant manufacturer's recommendations.

## Spray Finishes

Proprietary plasters with a total thickness of 3-4mm can be applied directly to blockwork that has been constructed to a suitable standard of plumbness and accuracy. These plasters are particularly suitable with, and compliment, the inherent accuracy which can be achieved using the Thin-Joint System.

# Wall fixings

Fixing into H+H Aircrete is easy. Plugs, with screws or nails as appropriate will provide a very secure and reliable fixing.

For lightweight fixtures (drawings 25 and 26) such as light-duty door frames, skirtings, linings and cladding battens, recommended fixings include cut nails, driven in pairs, skewed into the block work, or proprietary helical nails (see below). The nails should be driven to a minimum depth of 50mm into the block.

Medium-weight fixtures (drawing 27), for example, heavier-duty door frames and battens and small fixtures, should be fixed using proprietary plugs and normal woodscrews. The screws should penetrate the block to a minimum depth of 50mm, and when deciding the screw length, allowance must be made for the thickness of the internal finish as well as the item to be fixed.

When fixing battens etc., using helical nails, it may be helpful to drive the fixing through the timber before positioning, to avoid bounce.

Direct driven wood screws, with no plug may be used for fixing electrical back boxes and the like. Heavyweight items (drawing 28) such as radiators and cupboards should be fixed using proprietary plugs.

As a general rule, fixings should not be closer to the free edge of the block than the depth of embedment, nor should they be over-tightened as this can affect the pull out strength.

The diameter of holes drilled in blocks should be a size smaller than that normally recommended to ensure that the plug fits tightly in the block before the screw is driven.

The use of non-percussive power tools will help prevent over-sized pilot holes.

Advice on the most appropriate types of fixing for a given situation and pull-out values for a range of proprietary plugged and screwed fixings is readily available from the Technical Services Department.

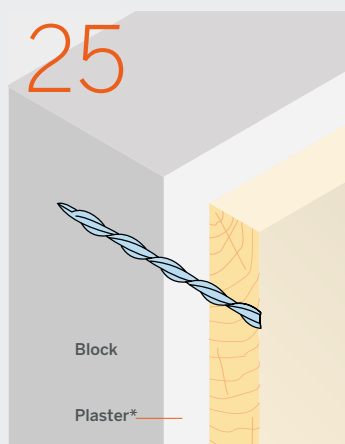

**Proprietary Nailed Fixing**  
Timber Fixtures such as light door frames, skirtings, linings and cladding battens

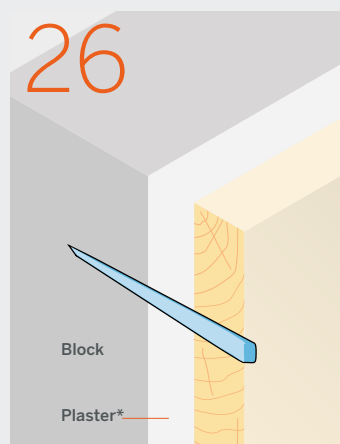

**Cut Nails (driven in pairs for Solar)**  
Timber Fixtures such as light door frames, skirtings, linings and cladding battens

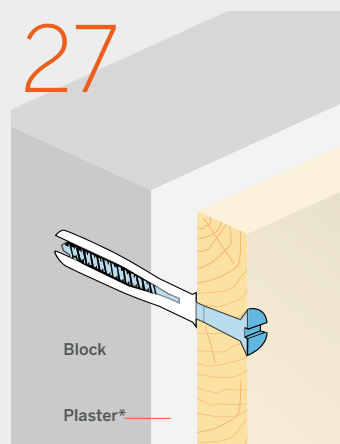

**Proprietary Plugs & Woodscrews**  
Heavier door frames, battens and small fixtures

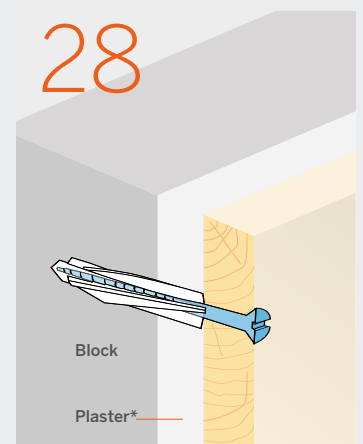

**Proprietary Heavyweight Fixings**  
Heavyweight items such as radiators and cupboards

\* With or without plaster

For further information and to check our most up-to-date product range, or to find your nearest stocking merchant, please visit our website [www.hhcelcon.co.uk](http://www.hhcelcon.co.uk) or contact the following departments:

**Sales**

For sales enquiries or to find your local stockist please contact

Tel: 01732 886444

Fax: 01732 887013

**Technical**

For technical enquiries please contact

Tel: 01732 880580

Fax: 01732 887013

Email: [technical.services@hhcelcon.co.uk](mailto:technical.services@hhcelcon.co.uk)

**Head Office**

H+H UK Limited

Celcon House

Ightham, Sevenoaks

Kent TN15 9HZ

Tel: 01732 886333

[www.hhcelcon.co.uk](http://www.hhcelcon.co.uk)

H+H UK will always endeavour to reflect our product range and technical information as accurately as possible. We may however, need to update both from time to time during the life of this brochure. Please check with either our Sales or Technical departments to obtain the latest information prior to specification and purchase.

January 2021

**CELCON**  
**PRODUCED in the uk**  
**AIRCRETE | EST.1949**  
**INSIDE**

